

Kansas Advocates
for
Better Care

CAREFUL CAREGIVING

*guide to hands-on caregiving skills
for non-professionals*

*We gratefully acknowledge funding from the
Sunflower Foundation, June 2002*

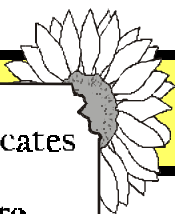

Introduction

KABC presents “**Careful Caregiving,**” an educational guide intended for family or other community members who are providing in-home, hands-on care for someone.

If you are helping someone with any of their daily needs, you are a caregiver - whether the help is “24-7” or once a week. A caregiver is a person who has been entrusted with, or has assumed the responsibility for, regular care of a dependent adult on a temporary or permanent basis, and who has a commitment or understanding with that person or that person’s guardian that a caregiver role exists. ‘Caregiver’ includes, but is not limited to, relatives, household members, guardians, neighbors and friends.

Remember, this guide does not replace professional medical attention

References

- ***Alzheimer’s Association*** 1/97 - 1/02
- ***Transfers for Patients with Acute & Chronic Conditions,***
American Rehabilitation Foundation 1970
- ***Careguide.com*** 1/02 and 2/02
- ***Caregiver Guide: Helping People with Incontinence,***
US Dept of Health & Human Services 1996
- ***Do it yourself again,*** American Heart Assn. 1965 - 1969
- ***Gerontology.com*** 2/99 and 12/99
- ***Kansas Certified Nurse Aide Guidelines*** 6/99
- ***NADAC, Alcohol Use in the Elderly*** 11/97
- ***Range of Joint Motion Exercises,***
Westwood Pharmaceuticals, Inc., NY 1972
- ***Up & Around,*** American Heart Association 1998

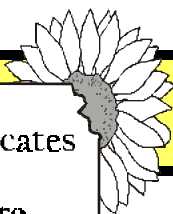

Careful Caregiving

1.	Before You Begin...	4
	The dilemma of communicating	
	Foster Independence	
	Ease Confusion	
	Safety Concerns	6
	Home environment	
	Vital signs	
	Medications	7
2.	Bathing	8
	Skin Care	10
	Grooming	10
3.	Dressing	11
4.	Elimination	12
	Bladder	12
	Bowel	13
5.	Feeding	14
	Nutrition	14
	Hydration	15
6.	Moving or Walking (Transfers, Ambulation)	16
	and Exercises (Range of Motion)	17
7.	End-of-Life	18
8.	Survival Tips for Caregivers	19

Foster Independence

- Never do for others what they can do for themselves.
- Foster independence, but assess for changes daily. If the decline is permanent, change what you do to help.
- Do set-ups for meals, bathing, dressing, brushing teeth, shaving and every task required in order to encourage independence with activities of daily living.
- Encourage movement at least once every hour. Skin cells die without oxygen. Sitting in a chair, couch, recliner or car for long periods without changing positions can cause bedsores and damage to tissues.
- Stand in front of the frail adult when talking, and look them in the eye.
- Make directions simple; do one task at a time.

Ease Confusion

Confusion and dementias are a loss of intellectual functions (such as thinking, remembering and reasoning) of sufficient severity as to interfere with daily functioning. They are not diseases themselves, but a group of symptoms which may accompany certain diseases and physical conditions. Alzheimer's Disease is the most common of these disorders.

A possible cause of confusion may be a physical reason:

- Medication interactions
- Overdose effects
- Infections
- Dehydration
- Poor Appetite.

Other causes of confusion may be mental status change, such as:

1. Withdrawal and/or depression, which may be:
 - Situational or chronic
 - A new condition (Assess for lack of socialization, activities or recent losses.)
2. Anxiety reactions (changes in thought processes, such as being fearful, having insomnia or poor sleep habits and paranoia), which may be:
 - Related to medication reactions or overdoses
 - Personality traits being accentuated when losses occur.
3. Panic attacks, evidenced by such behavior as:
 - "Sundowners" syndrome, with increased agitation, activity and confusion appearing after late afternoon.
 - Short term memory affected while long term memory remains pretty good (which may be remedied by exercises and conversations about the old days).

Appropriate Caregiver Responses to Inappropriate Behaviors

1. Aggressive behaviors

- Safety-proof the house and environment.
- Put away sharp objects or anything that could be a weapon.
- Do not turn your back to the care receiver.
- Look them in the eye and talk in a reassuring calm voice.
- Do not disagree or argue.
- Offer some comfort food or snack .
- Provide music or favorite distraction.

2. Wanderers

- Double lock outside doors.
- Keep lights lit in main areas of use.
- Warn the neighbors.
- Put identification on the person.
- Keep a recent picture available.
- Do activities.
- Consider pain as a cause, and seek medical help.

3. Spitters

- A spoonful of peanut butter does wonders.

4. Driving when prohibited/unsafe

- Have keys they can use that can't start the car.
- Disengage something in the car to prevent it from starting accidentally.

SUMMARY GUIDE ON CARING FOR THE CONFUSED

- Treat the confused person as an adult, always with respect.
- Create a calm environment.
- Appeal to their sense of humor.
- Do not argue.
- Always talk to them face-to-face; use gestures.
- Never assume that they do not understand what you are saying.
- Use simple directions, one task at a time.

Environmental, home safety issues

- Post emergency phone numbers in large print by the phone. (Include your home number and family members on this list.)
- Install telephones with large numbers and enhanced audio.
- Check that the fire extinguisher and smoke alarms are in working order.
- Check lighting in the house. Adequate lighting decreases depression and agitation, but watch out for glare.
- Position seating so that their back is to the light source.
- Maintain water heater at a temperature no higher than 120 degrees, to prevent burns.
- Alter height of bed to ease safe movement in or out.

Safety precautions to prevent falls

- Install grab bars and safety rails to help with getting up and down.
- Install an elevated toilet seat that has arm rests.
- Install an extended lever or pull-on faucet and toilet handle to make it easier to use.
- Provide a bedside commode to alleviate frequent trips to the bathroom, especially at night.
- Remove unnecessary rugs and furniture to keep walkways clear.
- Install night lights.
- Use non-skid mats in showers and tubs, and on front steps.

Cleanliness and infection control: Always wash hands before and after providing hands-on care, rubbing hands together at least ten times.

Observing and measuring vital signs: Temperature, Pulse, Respiration and Blood Pressure

Temperature: Body temperature is usually within a degree or two of 98.6 F. Temperature can be taken orally, auxiliary (under the arm/armpit) or rectally with a thermometer. Electronic thermometers are very accurate for home use.

Pulse: The pulse is normally full-bodied and regular. Usual checkpoints are: over the neck at the site of the carotid artery, above the wrist with 2 fingers or by directly listening over the heart. Do not use your thumb. Count pulse for 30 seconds, and double that number. Rate varies extensively from person to person. Anything between 54 and 94 may be considered normal. Disease can cause pulse to become weaker, irregular or change the rate.

Respiration: Rate of breathing is usually between 12 and 20 breaths per minute. Count the number of breaths by observing patient. If respiration is weak, place hand over chest area, or put your cheek close to their mouth to feel the breathing. Count 30 seconds, and double the amount.

Blood Pressures are considered in the normal or acceptable range as long as the systolic (top number) is under 160, and the diastolic (bottom number) is under 90. There are many machines available for home use to monitor blood pressure.

Drug non-compliance takes many forms:

- Omission or skipped doses
- Wrong dose
- Wrong time
- Regimen too complicated
- Unclear directions or monitoring of medications
- Poly-pharmacy (taking 9 or more drugs and/or getting prescriptions from more than one physician or pharmacist).

Potential problems with medications:

- Misuse of medications can cause falls, depression, delirium, constipation, urinary incontinence and drug toxicity.
- Elders process drugs more slowly. Dosages may need to be altered so blood level of the drug is not toxic, thereby causing adverse side-effects.
- If swallowing is a problem, or spitting out pills occurs, certain drugs can be crushed and mixed with applesauce, cottage cheese or jelly. (ALWAYS check with the pharmacist to see if crushing each medicine is acceptable.) Ask the pharmacist/physician if a liquid medication could be prescribed.
- PILLS IN GELATIN CAPSULE FORM USUALLY SHOULD NOT BE ALTERED.

SUMMARY GUIDE FOR ASSISTING WITH MEDICATIONS

- Keep a list of all medications, both prescription and over-the-counter drugs.
- Primary physician and pharmacist should be aware of everything taken, including laxatives, aspirin products, alcohol, etc. Have the pharmacist review all medications and tell you if they contradict each other.
- Set up medications on a weekly schedule, making it easier to check for compliance and to know which doses were missed, or if extra were taken:
 - Daily (once a day at about the same time each day)
 - Twice a day or BID (give at about the same time each day)
 - Before meals (AC), at least 30 minutes before eating
 - After meals (PC), make sure there is food in the stomach when taken
- A calendar or check-off sheet will help with scheduling or tracking medications.
- Individual cups, medicine organizers and small plastic envelopes are helpful to stay organized.
- Set up all medications including vitamins, laxatives and prescription items.

NOTE: ALCOHOL IS NOT PROHIBITED, BUT MUST BE PART OF THE REGIMEN SO IT DOES NOT ENHANCE, INHIBIT OR INTERACT NEGATIVELY WITH OTHER DRUGS. Alcohol usage is considered a drug (sedative). Oxygen usage is also considered a drug.

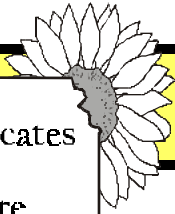

Bathing

Prepare the Bathroom in Advance:

- Install a grab bar on wall.
- Use non-skid mat in tub or shower.
- Provide a shower bench or stool.
- Have water drawn. Water should be 100-105 degrees Fahrenheit.
- Have towels ready. Place one on a chair for the person to sit on.
- Pre-measure shampoo.
- A hand-held shower hose is helpful.
- Develop a soap pocket in the washcloth to facilitate independence.
- If possible, use a chair with arms to provide more stability for bathing and dressing.

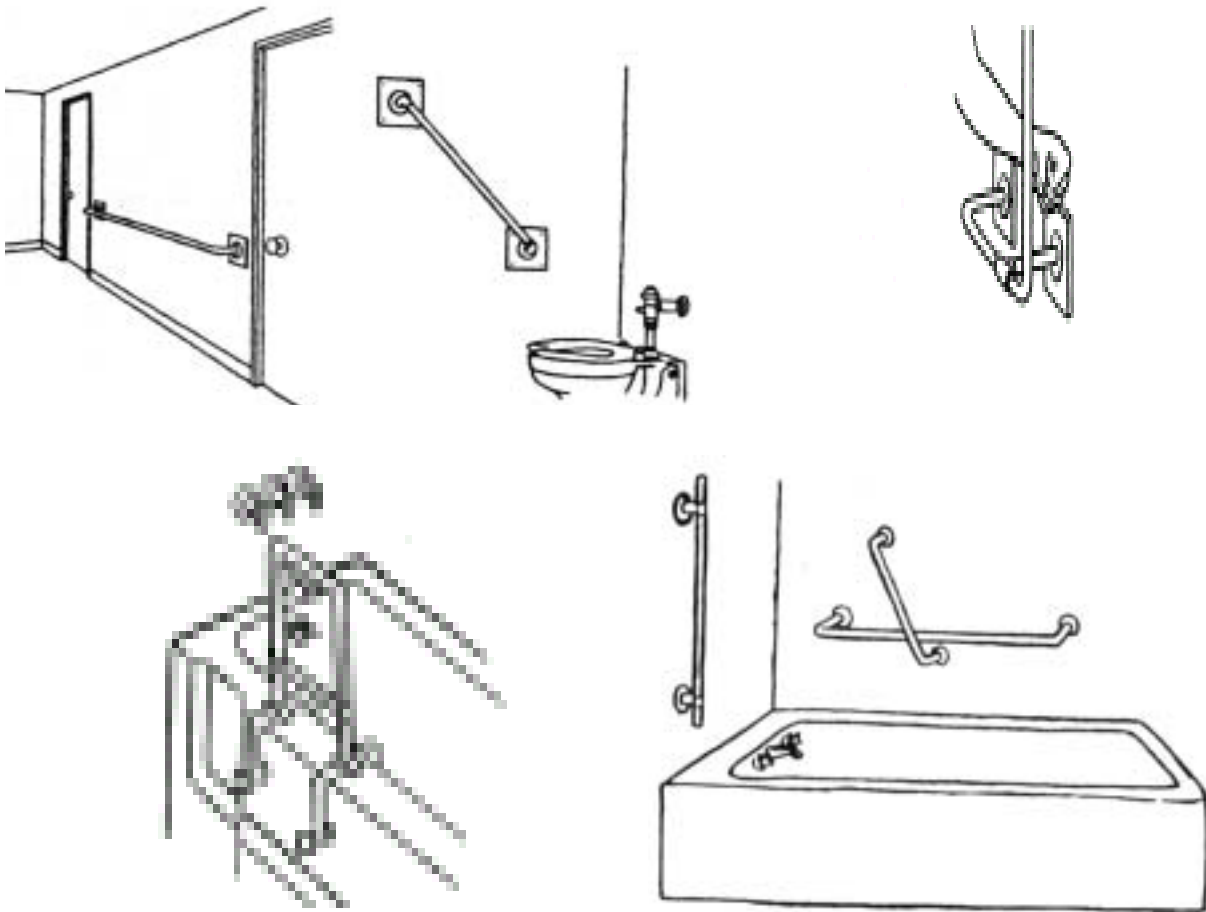

SUMMARY GUIDE WHEN ASSISTING WITH BATHING

- Usually, two baths per week are sufficient, as long as sponge-baths or genital cleansing is done as needed.
- Use soap sparingly; the older person's skin is more fragile and dry.
- Observe the skin for areas of redness, rashes or any breaks.
- Use this time for exercises. Encourage doing range of motion with arms and legs. Encourage deep breathing and stretching.
- If a bed-bath needs to be given, wash and dry one body part at a time, keeping remainder of body covered to prevent chilling and exposure.
- Pat skin to dry - **DO NOT RUB SKIN TO DRY.**
- If skin folds make drying the skin problematic, a hand-held hair dryer at **LOW HEAT** and **USED WITH CAUTION** is helpful.
- Cornstarch is a good powder to put in the skin folds to reduce moisture.
- Apply moisturizer.

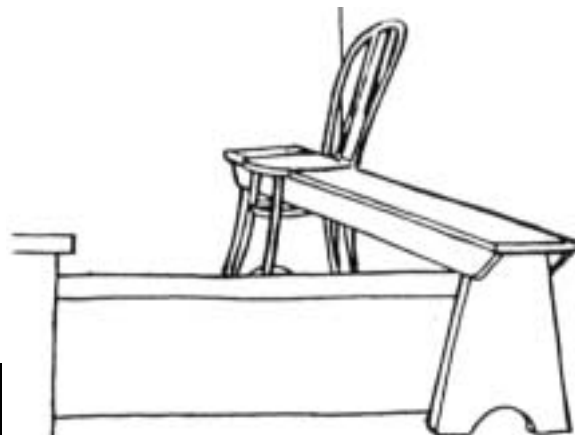
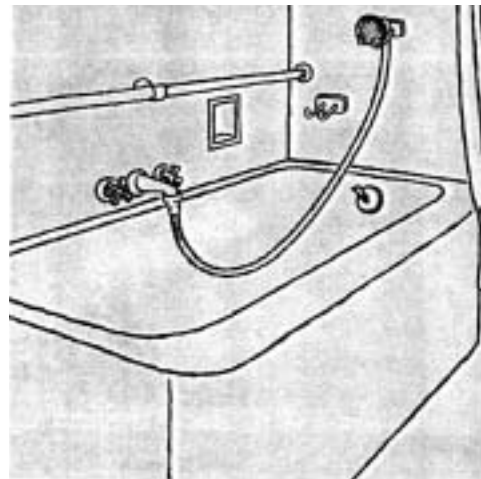
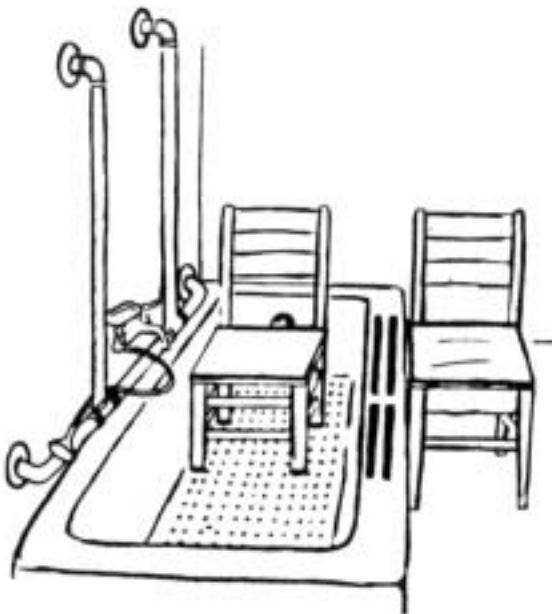

SUMMARY GUIDE FOR SKIN ASSESSMENT

Signs and symptoms of a pressure ulcer (also called bed sore):

- Redness
- Breaks in skin over any bony prominence.

Locations which are prone to ulcer formation:

- Hip
- Shoulder
- Ankle
- Elbows
- Heel

Alert the medical professional to any skin problems discovered.

SUMMARY GUIDE FOR CARE OF THE HAIR: Shampooing & Combing

- Hair should be shampooed once a week.
- Dry shampoos are helpful to use intermittently.
- Use baby shampoo or other mild shampoo.
- Be certain all shampoo is rinsed out to prevent dryness and itching scalp.
- Hair should be combed routinely, at least daily.
- Built-up handles on hair brushes can facilitate independence.
- Consider finding a barber or beautician who makes home appointments.

Shaving Facial Hair

- Beard care and shaving are a part of daily grooming.
- Electric razors are usually safer if you are doing the shaving.
- Promote independence, and do set-up as necessary.

SUMMARY GUIDE ON FINGERNAILS AND TOENAILS

- Do nail care after bathing.
- Toenails should be cut straight across.
- Medicare allows for podiatrist home visits for patients with diabetes, circulatory problems and other medical conditions.

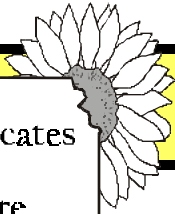

SUMMARY GUIDE FOR ASSISTING WITH DRESSING

- Looking presentable is critical to a person's well-being.
- Selecting clothing when one is ill may become overwhelming. Offer two choices.
- Clothing should feel soft and comfortable and be durable and washable, and easy to put on and take off.
- Jogging suits have few fasteners and are a good choice. Buying outfits in duplicate will make changing more acceptable for those who resist changing.
- If there is resistance to changing clothes, choose favorite colors and outfits.
- Provide shoes with adequate support, such as sneakers that slip on and off. Velcro closures or elasticized inserts, and non-skid soles will help prevent falls.
- Provide a chair with armrests while the person is getting dressed. This helps maintain balance.
- If there is a weak side or rigidity, always put clothing on the affected side first. Likewise, take clothing off the weak or affected side first when undressing.
- Help place affected limb (arm or leg) into clothing first since the unaffected limb is usually more limber and can bend to accommodate the clothing item.
- Dressing sticks, long-handled shoe horns, sock aides and leather loops on zippers are helpful devices.
- To facilitate or make it easier to change pants, have the person sitting in a chair or lying in bed, and roll from one side to the other to ease pants over hips.

NOTES:

Incontinence is Loss of Bladder or Bowel Control.

Possible causes of incontinence:

- Dehydration. At times, some people will restrict their fluid intake to prevent accidents. If the person prefers to restrict fluids, encourage them do so only after 6 p.m.
- Urinary tract infection symptoms include: burning or discomfort when urinating, low-grade fever, increased odor, dark orange color of urine.
- Constipation
- Prostate problems (in men)
- Medications or diuretics (water pills)
- Tranquilizers or sedatives
- Weak pelvic muscles
- Mobility problems, which make getting to the bathroom in a timely manner a problem. A bedside commode will help, especially at night.

Assisting someone for proper skin care, genital care and comfort after toileting:

- Always wipe from front to back, and assist as necessary.
- Pour warm water over the genitals to wash/cleanse as necessary, while the person is sitting on the toilet .
- Wash or sponge-off after each incontinent episode .
- A hand-held hair dryer on LOW, COOL SETTING, and USED WITH CAUTION, thoroughly dries the skin.
- Promote independence, but assist with clothing.

SUMMARY GUIDE FOR ASSISTING WITH TOILETING FOR BLADDER

- Notice normal and abnormal appearance of urine and abnormal sensation while urinating. (If the urine is dark orange and odorous, consider increasing fluid intake. Six to 8 glasses of water every 24 hours is recommended.)
- **Remember, coffee, colas and tea may contribute to incontinence.**
- Scheduled or prompted toileting can prevent incontinent episodes. The schedule may be to toilet before and/or after meals. Encourage or prompt every 2 to 4 hours.
- After the person has been lying down for an hour, offer to toilet. This will frequently empty the bladder enough to prevent nighttime incontinence.
- Try *double voiding*: the person should urinate, stand up and gently massage lower abdomen, then sit down and attempt to empty bladder again.
- Males will empty their bladder better if standing up.
- Accidents are embarrassing. Avoid blaming or scolding. Plan ahead - use incontinent pad for special events or outings if necessary. Pads, protective beddings, panty liners or adult diapers are available.

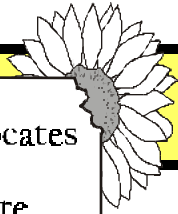

Elimination (Toileting): Bowel

SUMMARY GUIDE FOR ASSISTING WITH TOILETING FOR BOWEL

- A normal appearance of stool or feces resembles the consistency and color of an over-ripe banana.
- Most people evacuate feces daily, but some only every 2nd or 3rd day.
- Constipation is more frequent in the aged person due to decreased motility (movement) in the gastro-intestinal tract.
- Fecal impaction occurs when the motility of the intestinal tract stops and no evacuation of gas or stool occurs. This can constitute a medical emergency, and laxatives, rectal suppositories or enemas should be done under a nurse's or physician's directive.
- Have a schedule to toilet after a meal to encourage regularity and prevent constipation.
- Adequate fluid intake and a diet with roughage, as tolerated, is required to prevent constipation.
- Measures to prevent or relieve constipation can include using the following 'Fruit Lax' or 'Power Pudding' recipes.

FRUIT LAX

- 1/2 cup raisins, softened in orange juice
- One or two cored apples, with peeling
- One large orange, peeled
- Honey to taste

Mix in blender and store in the refrigerator. Take 1 to 4 Tbsp. daily.

POWER PUDDING

- Equal amounts of
 - bran cereal
 - prune juice
 - applesauce.

Mix together and store in the refrigerator. Take 1 to 4 Tbsp. daily.

NOTES:

Assess the Nutritional Setting - Possible Problems:

- Weight loss
- Poor Appetite? Consider:
 - Medication interactions
 - Poor-fitting dentures
 - Poor oral hygiene
 - Dehydration
 - Constipation
- Chewing or swallowing problems
- Dietary restrictions
- Chronic diseases, such as cardiac problems, diabetes, depression or constipation
- Sensory problems with sight, smell, etc.
- Lack of food preferences offered
- Lack of schedule of 3 meals daily, 5 meals, or snacks every 2-3 hours
- Lack of social setting - provide for a meal with others, whenever possible
- Disruptive setting; provide a calm environment. Make mealtime simple, but pleasant.

Pre-Meal Remedies

- Increase physical activity, but not so much that the person tires out before meals.
- Rinse mouth with lemon water or small glass of juice before eating.
- Prepare/offer favorite foods.
- Use supplements to add calories/protein (for people without dietary restrictions) such as: dry skim milk in cereals, gravies, sauces, puddings, instant breakfast, milk shakes, etc. If choking is a problem, serve thicker liquids, i.e. shakes, nectars and offer fluids with food. Milk products are sometimes restricted if choking is a problem.

SUMMARY GUIDE FOR ASSISTING WITH FEEDING

- The person should sit up straight, with head slightly forward.
- Offer finger foods or sandwiches in small portions.
- Serve soft foods, such as scrambled eggs, applesauce, cottage cheese.
- Offer a drink after every third mouthful.
- Use bowls, or a plate with a rim.
- Use silverware/spoons with large handles.
- Use cups or mugs, even "sippy" cups. Fill glasses half full and use straws that bend.
- Use plastic tablecloth, napkins or bibs to facilitate cleanup.
- Allow plenty of time for a meal or snack.
- Assist as necessary, such as cutting up food. Arrange food on plate the same way each time (helps the visually impaired).
- Set plate on non-skid surface.
- Limit very sweet and salty items.
- Maintain oral hygiene. Make sure mouth is empty when meal is finished.
- Learn the Heimlich Maneuver.

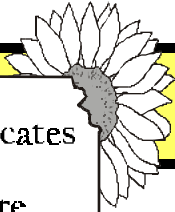

Importance of Adequate Hydration

- Essential to maintain skin integrity and good health
- Essential to prevent urinary tract infection and constipation
- Lack of fluids is the primary factor for confusion in the frail elderly. Six to eight glasses of water a day is ideal, UNLESS ON PHYSICIAN-ORDERED FLUID RESTRICTIONS.

SUMMARY GUIDE TO ENCOURAGE ADEQUATE FLUID INTAKE

- Measure fluid out in four-ounce glass every two hours, and encourage frequent sips.
- Offer any fluid, but water is preferable. All liquids or foods that liquefy at room temperature can be counted as fluids (i.e., Jell-O, ice cream, etc.).
- Limit carbonated and caffeine drinks.
- Have a way to measure approximate intake every day.

Frail adults will sometimes not recognize thirst, and can easily become dehydrated. Electrolyte imbalance caused by dehydration can contribute to several other problems, such as urinary tract infections, confusion, etc.

For those resistant to adequate fluid intake, offer the following Energy Tea Drink to help avoid or correct electrolyte imbalance, or the flavored Gelatin Drink to encourage adequate fluid intake:

ENERGY TEA DRINK

1 QUART WEAK TEA
1 TABLESPOON SUGAR
1 TEASPOON SALT
LEMON

GELATIN DRINK

2 QUARTS WATER*
1 PACKAGE GELATIN
DESSERT MIX (JELL-O)
1 TEASPOON SALT (optional)

* dissolve gelatin in 1 cup of very hot water before adding the remaining water and salt.

NOTES:

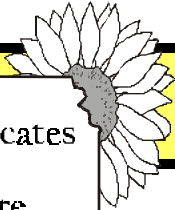

Moving & Walking (Transfers)

Basic Transfer:

- The person should be in a sitting position near the edge of the chair or bed. By leaning forward and doing short push-ups, they can usually move themselves a little.

Stages of Assisting with Transfers

Minimum help:

- Stand on weak side, and place hand under weak arm to assist.
- Grasp by belt or top of pants to assist.

Limited Assistance:

- Stand in front of person, with your feet well apart, and one foot slightly behind to maintain your balance.
- Place your arms under both armpits, with hands well onto the back.
- A transfer or gait belt may need to be used.
- Keep person's weight forward. Keep your feet well apart, and lift with your legs, rather than your back.

Total assistance:

- Place your right knee against person's strong knee.
- Grasp around the waist with both arms and pull forward, using your right leg and his strong leg as a pivot.
- Turn person around and lower onto chair.



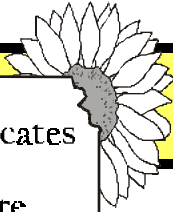

Moving & Walking (Ambulation)

Assisting with stairs or curbs:

- Climbing - use hand rail on strong side.
- Go up with strong foot first.
- Using strong hand and strong leg, lean forward, straighten strong knee and place weak foot beside strong foot on the same step.
- Go down stairs or curb with weak foot first. Use hand rail.
- Make sure toes of strong foot overlap edge of step before starting down. It is usually easier to place weak foot on next step below.

Assisting person who walks with support:

Watch that the person:

- Uses cane or wide base cane by placing cane ahead of strong foot, and bringing weak foot forward.
- Does not let weak foot get ahead of the cane or crutch.
- Takes short steps.
- Uses a cane with a safety tip.

Assisting with Exercise (Range of Motion - ROM)

- Range of motion exercise is the extent of movement within a given joint.
- ROM may be used for almost any type of disability.
- It is important to keep person as active and independent as possible.
- Consider exercises to the neck, shoulders, elbows, wrists, fingers, hips, knees, ankles and feet.
- Do gently, and only bend the joint as far as comfort allows.
- Consider doing ROM exercises during bathing and dressing.



Caring for the Dying Resident

The terms 'Active Dying' or 'Palliative Care' describe the care and support given to people at the end stages of life. Many prefer to die at home in their own surroundings. Determine if hospice care is advisable. Hospice care uses a team approach of professionals to provide palliative care for pain control, along with emotional support for the family members and person at the end of life. (Medicare usually covers the cost of hospice care. Talk to the physician.)

SUMMARY GUIDE ON PHYSICAL AND EMOTIONAL CAREGIVING AT END OF LIFE

- Body systems tend to shut down, so soothing and comfort services are important.
- Do not force feed, but offer foods and fluids frequently.
- Oral care is important to keep the mouth and lips clean and moistened. One way to help keep lips moistened is using lemon swabs (or a piece of fruit, such as watermelon or other favorite) to run over the lips.
- The body should be oiled and lightly massaged.
- Bathing in the normal sense with soap and water should only be done if necessary.
- The genital area can be cleaned with baby oil or moisturizer creams on a very soft cloth.
- Maintain hair care and good grooming only as a comfort measure.
- Touching sometimes causes discomfort, so be aware of what is acceptable. Touch without pressure. When massage is given, do very lightly.
- The last sense to go is usually the hearing. Continue to talk in a soothing, calm voice. Have music on, if person has always derived pleasure from music.
- Aroma therapy may be comforting to the sense of smell. Sometimes the smell of food is desirable even after there is no desire to eat.
- Physical changes include irregular and weak respirations, and discoloration or mottling of the skin due to loss of oxygen circulating through the system.

NOTES:

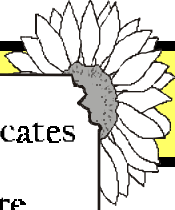

Survival Reminders to Caregivers

All too often, caregivers are so busy doing the caring, that they tend to forget to care for themselves. The following suggestions may help alleviate some of the feelings of frustration or anxiety that can be a part of caring for the frail.

- Have a daily schedule that includes activities and breaks for yourself.
- Maintain your own nutritional well being, in order to keep up energy levels and resistance to illness.
- Get adequate rest, at least 8 hours of uninterrupted sleep every two or three nights.
- Recognize what you can and cannot do. If you are awake during the night providing help, get some relief help from family and/or friends to avoid burnout.
- Take one day at a time, but prepare for the future. Become educated and aware of all the choices for provision of care.
- Take pride in the care and comfort you give, but accept/ask for help from family and friends when the need arises.
- Seek professional assistance as needed. For example, allow for times that may require respite care, financial and legal advice, and/or attendance at local support groups. There are numerous website resources for caregivers, for example:

www.k4s.org (The Kansas Department on Aging)

www.caregiver.org

www.agenet.com

www.careguide.com

www.caregiverchat.com (chatline)

www.thirdage.com/family/caregiving

www.galaxymall.com

www.caregiver.on.ca

www.caregiver.com

www.kabc.org (Kansas Advocates for Better Care)

- Be aware that the caregiver role may be more demanding than you can provide for an extended length of time. Be prepared to consider placement in a long-term care facility.

NOTES:



About Kansas Advocates

Founded in 1975 as *Kansans for Improvement of Nursing Homes (KINH)*, Kansas Advocates for Better Care continues to be the only statewide non-profit organization working to improve the quality of long-term care in Kansas.

This 501(c)3 organization is supported entirely by membership dues, contributions, sales from consumer information products and grants for special projects. Members receive five data-rich newsletters each year. The volunteer Board of Directors includes consumers, health care providers and business leaders from across the state.

RN Consultant: Isla Richards, a Kansas-licensed nurse, has more than 45 years of healthcare experience, approximately 35 years in gerontology and 13 years in state regulations and enforcement.